



### EverLast® Induction Lighting EHB-AC-100W

- Wattage: 100w
- Lamp Life Rating: 100,000 hours
- Ballast Life Rating: 60,000 hours
- CCT: 5000k
- CRI: 82-85
- IP Rating: IP43 (control gear)
- Vibration & Shock Resistance: Excellent
- Applications: Warehouses, factories, showrooms, gymnasiums

## Specifications

### Lamp

Wattage (W)	Lumens (LM)	CRI	CCT (Kelvin)	Rated Life (Hours)
<b>100</b>	<b>8,400</b>	<b>82-85</b>	<b>5000</b>	<b>100,000</b>

### Ballast

Input Power (W)	Input Voltage (V)	Input Current (A)	Input Freq. (Hz)	Power Factor (PF)	Operating Temp. (°F)	THD (%)
<b>105</b>	<b>120-277</b>	<b>0.93-0.42</b>	<b>50/60</b>	<b>&gt;.95</b>	<b>-20 to 100</b>	<b>&lt;10</b>

### Physical Specifications

- Aluminum reflector with anodized inner surface
- Die cast aluminum ballast casing with corrosion-resistant white powder coat finish
- Simple latching hook or pendant mounting system
- Electronic ballast with high power factor

**EverLast® Induction Lighting EHB-AC-100W**

**Dimensions**

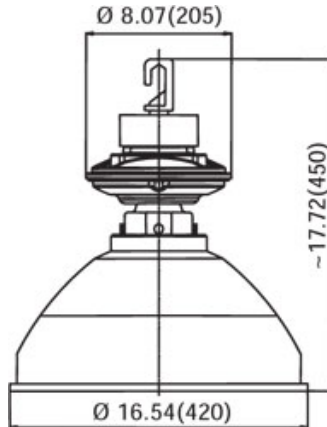

**Photometric Data**

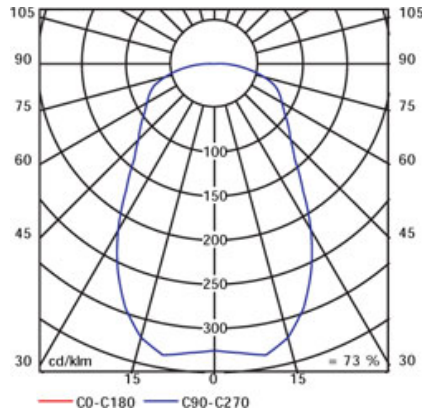

**EverLast® 5/5 Zero Maintenance Warranty**

Full Spectrum Solutions (manufacturer) warrants that its fixtures shall be free from defects in materials and workmanship for a period of 10 years from the date of purchase. Ballasts shall be free from defects in materials and workmanship for a period of 5 years from the date of purchase. Manufacturer warrants that its lamps shall be free from defects in materials and workmanship for a period of 5 years from date of delivery. Use of product inconsistent with product instructions and specifications will void warranty. Full Spectrum Solutions will not honor warranty claims for defects caused by improper installation, use or maintenance. Manufacturer shall, at its option, either replace or repair defective ballasts for valid warranty claims. FULL SPECTRUM SOLUTIONS MAKES NO OTHER WARRANTY, EXPRESSED OR IMPLIED THAT THE GOODS ARE MERCHANTABLE OR FIT FOR ANY PARTICULAR PURPOSE. BUYER ACKNOWLEDGES THAT BUYER IS NOT RELYING ON SELLER'S SKILL OR JUDGMENT TO SELECT OR FURNISH GOODS SUITABLE FOR ANY PARTICULAR PURPOSE. **CERTAIN RESTRICTIONS MAY APPLY DEPENDING ON PRODUCT USE AND APPLICATION.**



## EverLast® Induction Lighting EHB-AC-150W

- Wattage: 150w
- Lamp Life Rating: 100,000 hours
- Ballast Life Rating: 60,000 hours
- CCT: 5000k
- CRI: 82-85
- IP Rating: IP43
- Vibration & Shock Resistance: Excellent
- Applications: Warehouses, factories, showrooms, gymnasiums

### Specifications

#### Lamp

Wattage (W)	Lumens (LM)	CRI	CCT (Kelvin)	Rated Life (Hours)
<b>150</b>	<b>13,000</b>	<b>82-85</b>	<b>5000</b>	<b>100,000</b>

#### Ballast

Input Power (W)	Input Voltage (V)	Input Current (A)	Input Freq. (Hz)	Power Factor (PF)	Operating Temp. (°F)	THD (%)
<b>165</b>	<b>120-277</b>	<b>1.35-0.61</b>	<b>50/60</b>	<b>&gt;.95</b>	<b>-20 to 120</b>	<b>&lt;10</b>

#### Physical Specifications

- Aluminum reflector with anodized inner surface
- UV stabilized acrylic or tempered glass lens
- Die cast aluminum ballast casing with corrosion-resistant white powder coat finish
- Simple latching hook or pendant mounting system
- Electronic ballast with high power factor

**EverLast® Induction Lighting EHB-AC-150W**

**Dimensions**

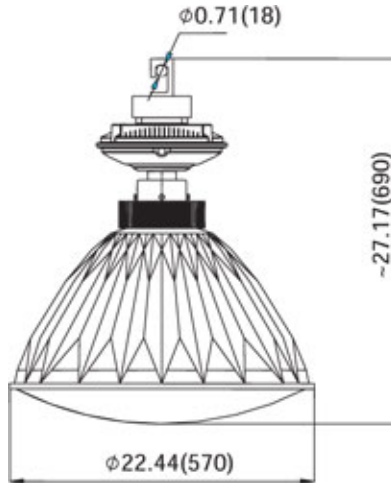

**Photometric Data**

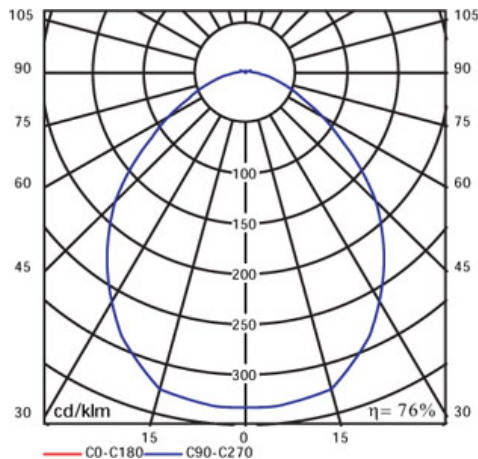

**EverLast® 5/5 Zero Maintenance Warranty**

Full Spectrum Solutions (manufacturer) warrants that its fixtures shall be free from defects in materials and workmanship for a period of 10 years from the date of purchase. Ballasts shall be free from defects in materials and workmanship for a period of 5 years from the date of purchase. Manufacturer warrants that its lamps shall be free from defects in materials and workmanship for a period of 5 years from date of delivery. Use of product inconsistent with product instructions and specifications will void warranty. Full Spectrum Solutions will not honor warranty claims for defects caused by improper installation, use or maintenance. Manufacturer shall, at its option, either replace or repair defective ballasts for valid warranty claims. FULL SPECTRUM SOLUTIONS MAKES NO OTHER WARRANTY, EXPRESSED OR IMPLIED THAT THE GOODS ARE MERCHANTABLE OR FIT FOR ANY PARTICULAR PURPOSE. BUYER ACKNOWLEDGES THAT BUYER IS NOT RELYING ON SELLER'S SKILL OR JUDGMENT TO SELECT OR FURNISH GOODS SUITABLE FOR ANY PARTICULAR PURPOSE. **CERTAIN RESTRICTIONS MAY APPLY DEPENDING ON PRODUCT USE AND APPLICATION.**



**EverLast® Induction Lighting EHB-AC-200W**

- Wattage: 200w
- Lamp Life Rating: 100,000 hours
- Ballast Life Rating: 60,000 hours
- CCT: 5000k
- CRI: 82-85
- IP Rating: IP43
- Vibration & Shock Resistance: Excellent
- Applications: Warehouses, factories, showrooms, gymnasiums

**Specifications**

**Lamp**

Wattage (W)	Lumens (LM)	CRI	CCT (Kelvin)	Rated Life (Hours)
200	18,250	82-85	5000	100,000

**Ballast**

Input Power (W)	Input Voltage (V)	Input Current (A)	Input Freq. (Hz)	Power Factor (PF)	Operating Temp. (°F)	THD (%)
215	120-277	1.77-0.80	50/60	>.95	-20 to 120	<10

**Physical Specifications**

- Aluminum reflector with anodized inner surface
- UV stabilized acrylic or tempered glass lens
- Die cast aluminum ballast casing with corrosion-resistant white powder coat finish
- Simple latching hook or pendant mounting system
- Electronic ballast with high power factor

**EverLast® Induction Lighting EHB-AC-200W**

**Dimensions**

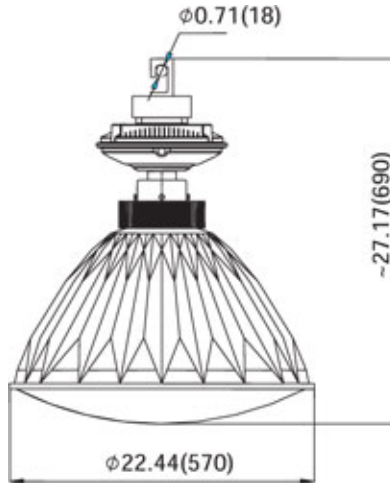

**Photometric Data**

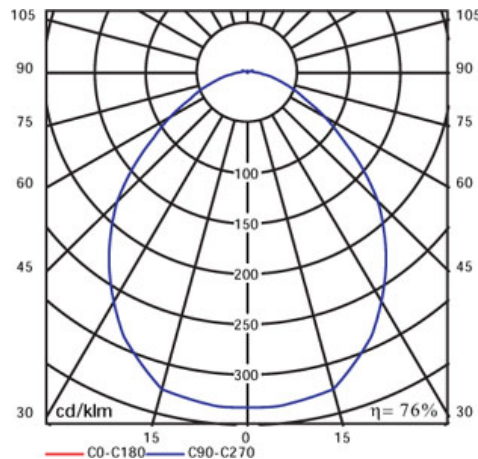

**EverLast® 5/5 Zero Maintenance Warranty**

Full Spectrum Solutions (manufacturer) warrants that its fixtures shall be free from defects in materials and workmanship for a period of 10 years from the date of purchase. Ballasts shall be free from defects in materials and workmanship for a period of 5 years from the date of purchase. Manufacturer warrants that its lamps shall be free from defects in materials and workmanship for a period of 5 years from date of delivery. Use of product inconsistent with product instructions and specifications will void warranty. Full Spectrum Solutions will not honor warranty claims for defects caused by improper installation, use or maintenance. Manufacturer shall, at its option, either replace or repair defective ballasts for valid warranty claims. FULL SPECTRUM SOLUTIONS MAKES NO OTHER WARRANTY, EXPRESSED OR IMPLIED THAT THE GOODS ARE MERCHANTABLE OR FIT FOR ANY PARTICULAR PURPOSE. BUYER ACKNOWLEDGES THAT BUYER IS NOT RELYING ON SELLER'S SKILL OR JUDGMENT TO SELECT OR FURNISH GOODS SUITABLE FOR ANY PARTICULAR PURPOSE. **CERTAIN RESTRICTIONS MAY APPLY DEPENDING ON PRODUCT USE AND APPLICATION.**



**EverLast® Induction Lighting EHB-AC-250W**

- Wattage: 250w
- Lamp Life Rating: 100,000 hours
- Ballast Life Rating: 60,000 hours
- CCT: 5000k
- CRI: 86-90
- IP Rating: IP43
- Vibration & Shock Resistance: Excellent
- Applications: Warehouses, factories, showrooms, gymnasiums

**Specifications**

**Lamp**

Wattage (W)	Lumens (LM)	CRI	CCT (Kelvin)	Rated Life (Hours)
250	22,500	86-90	5000	100,000

**Ballast**

Input Power (W)	Input Voltage (V)	Input Current (A)	Input Freq. (Hz)	Power Factor (PF)	Operating Temp. (°F)	THD (%)
265	120-277	2.21-1.00	50/60	>.95	-20 to 120	<10

**Physical Specifications**

- Aluminum reflector with anodized inner surface
- UV stabilized acrylic or tempered glass lens
- Die cast aluminum ballast casing with corrosion-resistant white powder coat finish
- Simple latching hook or pendant mounting system
- Electronic ballast with high power factor

**EverLast® Induction Lighting EHB-AC-250W**

**Dimensions**

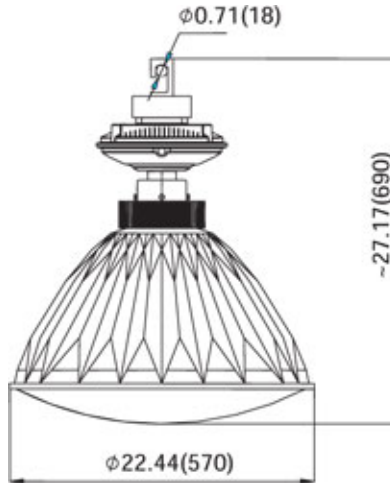

**Photometric Data**

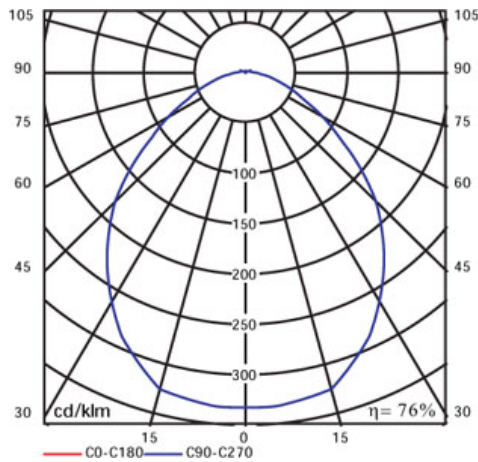

**EverLast® 5/5 Zero Maintenance Warranty**

Full Spectrum Solutions (manufacturer) warrants that its fixtures shall be free from defects in materials and workmanship for a period of 10 years from the date of purchase. Ballasts shall be free from defects in materials and workmanship for a period of 5 years from the date of purchase. Manufacturer warrants that its lamps shall be free from defects in materials and workmanship for a period of 5 years from date of delivery. Use of product inconsistent with product instructions and specifications will void warranty. Full Spectrum Solutions will not honor warranty claims for defects caused by improper installation, use or maintenance. Manufacturer shall, at its option, either replace or repair defective ballasts for valid warranty claims. FULL SPECTRUM SOLUTIONS MAKES NO OTHER WARRANTY, EXPRESSED OR IMPLIED THAT THE GOODS ARE MERCHANTABLE OR FIT FOR ANY PARTICULAR PURPOSE. BUYER ACKNOWLEDGES THAT BUYER IS NOT RELYING ON SELLER'S SKILL OR JUDGMENT TO SELECT OR FURNISH GOODS SUITABLE FOR ANY PARTICULAR PURPOSE. **CERTAIN RESTRICTIONS MAY APPLY DEPENDING ON PRODUCT USE AND APPLICATION.**



**EverLast® Induction Lighting EHB-AC-300W**

- Wattage: 300w
- Lamp Life Rating: 100,000 hours
- Ballast Life Rating: 60,000 hours
- CCT: 5000k
- CRI: 86-90
- IP Rating: IP43
- Vibration & Shock Resistance: Excellent
- Applications: Warehouses, factories, showrooms, gymnasiums

**Lamp**

Wattage (W)	Lumens (LM)	CRI	CCT (Kelvin)	Rated Life (Hours)
300	27,500	86-90	5000	100,000

**Ballast**

Input Power (W)	Input Voltage (V)	Input Current (A)	Input Freq. (Hz)	Power Factor (PF)	Operating Temp. (°F)	THD (%)
320	120-277	2.65-1.20	50/60	>.95	-20 to 120	<10

**Physical Specifications**

- Aluminum reflector with anodized inner surface
- UV stabilized acrylic lens with clamping band
- Die cast aluminum ballast casing with corrosion-resistant white powder coat finish
- Simple latching hook or pendant mounting system
- Electronic ballast with high power factor

**EverLast® Induction Lighting EHB-AC-300W**

**Dimensions**

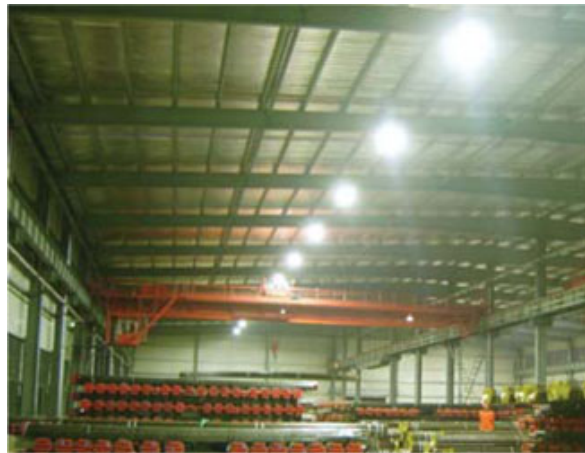
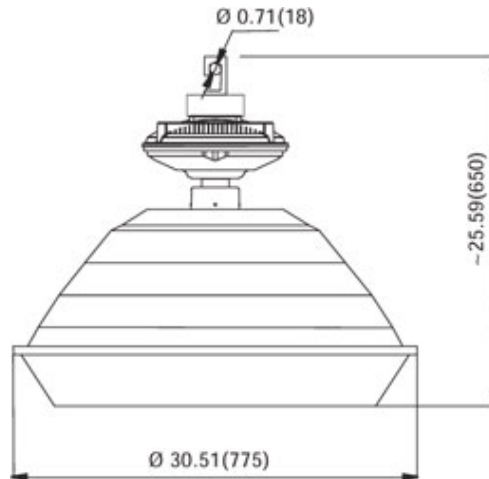

**EverLast® 5/5 Zero Maintenance Warranty**

Full Spectrum Solutions (manufacturer) warrants that its fixtures shall be free from defects in materials and workmanship for a period of 10 years from the date of purchase. Ballasts shall be free from defects in materials and workmanship for a period of 5 years from the date of purchase. Manufacturer warrants that its lamps shall be free from defects in materials and workmanship for a period of 5 years from date of delivery. Use of product inconsistent with product instructions and specifications will void warranty. Full Spectrum Solutions will not honor warranty claims for defects caused by improper installation, use or maintenance. Manufacturer shall, at its option, either replace or repair defective ballasts for valid warranty claims. FULL SPECTRUM SOLUTIONS MAKES NO OTHER WARRANTY, EXPRESSED OR IMPLIED THAT THE GOODS ARE MERCHANTABLE OR FIT FOR ANY PARTICULAR PURPOSE. BUYER ACKNOWLEDGES THAT BUYER IS NOT RELYING ON SELLER'S SKILL OR JUDGMENT TO SELECT OR FURNISH GOODS SUITABLE FOR ANY PARTICULAR PURPOSE. **CERTAIN RESTRICTIONS MAY APPLY DEPENDING ON PRODUCT USE AND APPLICATION.**